

Beach Hut 1200

BRBEA1200

Available add-on items include:

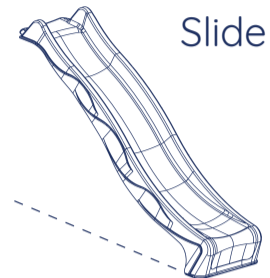

Slide

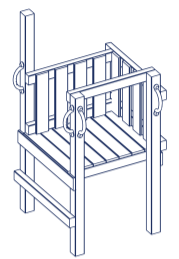

Platform



Steps

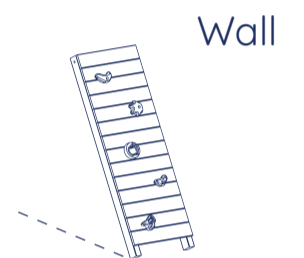

Wall

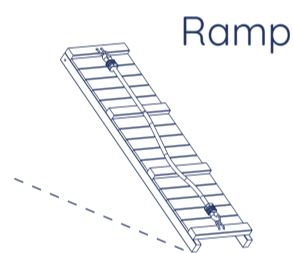

Ramp

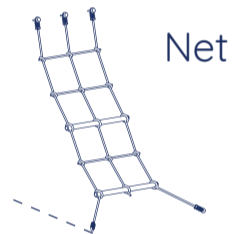

Net

Bridge

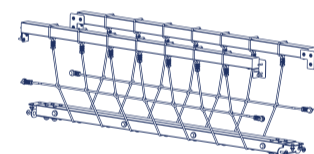

Swing

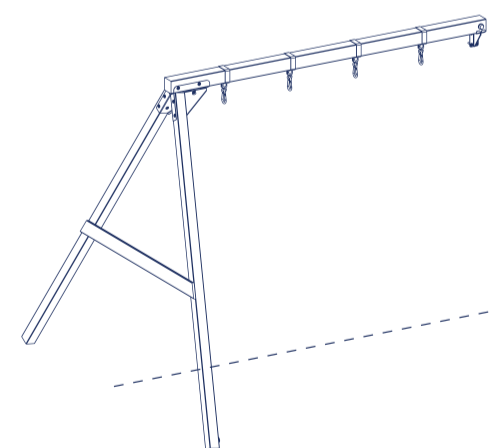

Challenger

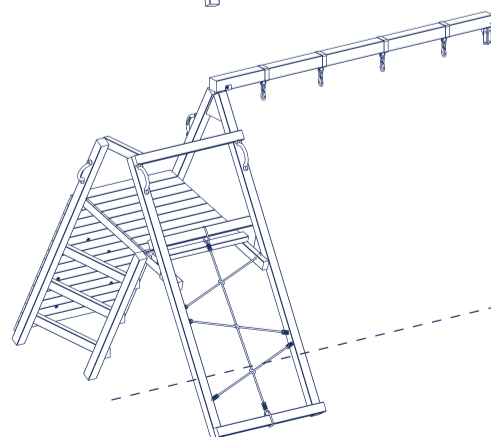

TECHNICAL SPECIFICATION:

Base unit measures:
2150mm L x 1750mm W x 2990mm H

Fall height: 1.2m